

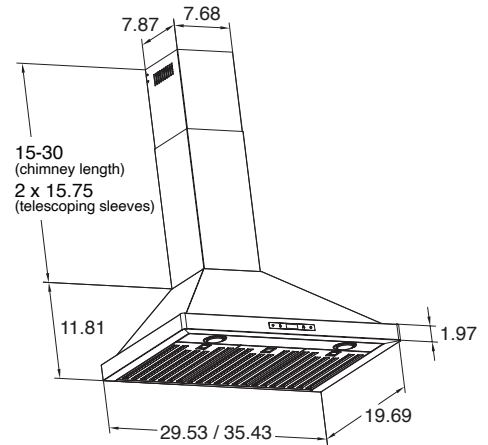

## PLSW 520

The PLSW 520 Wall Mounted Range Hood marks a significant leap forward in kitchen ventilation, blending cutting-edge technology with superior performance and sleek aesthetics. At its core, a powerful 550 CFM motor efficiently purges smoke, odors, and impurities, ensuring a clean cooking environment. Designed for eco-conscious efficiency, it maximizes airflow while minimizing energy consumption. Operating quietly at 13 Sones/65 dB, the PLSW 520 achieves a perfect balance between robust performance and serene operation, thanks to high-quality components that reduce vibration and noise. This model is enhanced with two 1.5W LED lights for bright, energy-efficient illumination, and a digital touch control panel offering three adjustable speeds for tailored ventilation. With a 6" round outlet for optimal air expulsion, the PLSW 520 stands as a testament to innovation in modern kitchen ventilation, embodying our commitment to enhancement and innovation.



### Configuration and Dimensions

Hood Type . . . . .	Wall Mounted
Sizes Available . . . . .	30   36
30" Dimensions. . . . .	29.53" W x 16.69" D x 11.81" H
36" Dimensions. . . . .	35.43" W x 16.69" D x 11.81" H

### Features

Control Type . . . . .	Digital Touch Control
Lighting . . . . .	1.5W LED

### Ventilation System

Maximum Air Flow Capacity . . . . .	550 CFM
Speed Levels . . . . .	3 Speed
Airflow (Quiet/Low/Med/High). . . . .	150/350/550
Noise Level . . . . .	.65 db or 13 Sones Max
Duct Type/Size . . . . .	6" Round
Voltage . . . . .	110v
Motor . . . . .	Single
Filter Type . . . . .	Stainless Steel Baffle (Dishwasher Safe)
Material . . . . .	High Quality 430 Stainless Steel
Warranty . . . . .	.3 Year Parts Warranty