

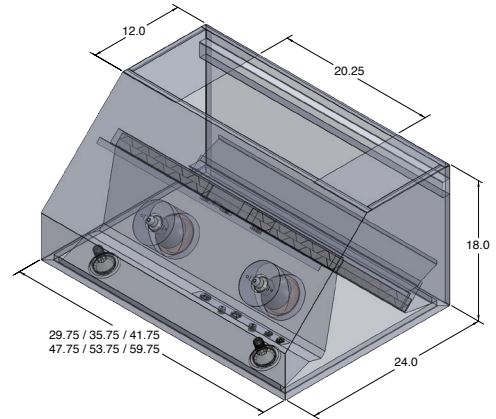

The PLGW 105HE is a surefire way to improve your indoor air quality. You have the freedom to choose between a 1200 CFM local blower, a 1700 CFM local blower, or a 1300 CFM inline blower. These robust blowers all boast more than enough power to ensure that your kitchen air stays clean and fresh. We want you to enjoy the time and delicious food that you have with your friends, family, and guests, and buying the PLGW 105HE is a step in the right direction. It's easy to use thanks to the variable speed dial knob controls that make adjusting blower power and lights a breeze. Once you've finished in the kitchen and you're ready to join your family, set the baffle filters in the dishwasher so they are ready to clean at a moment's notice. Try out the PLGW 105HE wall range hood from Proline today.



Configuration and Dimensions

Hood Type	Under Cabinet
Sizes Available30 36 48 60
30" Dimensions.	29.75" W x 24" D x 18" H
36" Dimensions.	35.75" W x 24" D x 18" H
42" Dimensions.	41.75" W x 24" D x 18" H
48" Dimensions.	47.75" W x 24" D x 18" H
54" Dimensions.	53.75" W x 24" D x 18" H
60" Dimensions.	59.5" W x 24" D x 18" H

Features

Control Type	Rheostat Knobs
Lighting	Halogen or LED

Ventilation System

Maximum Air Flow Capacity	1200, 1300 or 1700 CFM
Speed Levels	Variable Speeds
Airflow (Quiet/Low/Med/High).	0-1200, 0-1300 or 0-1700
Noise Level	56.1 db or 7 Sones Max
Duct Type/Size	Round 10
Voltage	110v
Motor	Single High efficiency Variable/Inline option
Filter Type	Stainless Steel Baffle (Dishwasher Safe)
Material	High Quality 304 Stainless Steel
Warranty3 Year Parts Warranty